

Radial Lead Resettable Polymer PTCs

SC250-080CW1A

Description

The SC250-080CW1A is designed to protect against short duration high voltage fault currents (power cross or power induction surge) typically found in telecom applications (250Vrms). The series can be used to help telecom networking equipment meet the protection requirements specified in ITU K.20 and K.21.

Features

- ◆ 0.08A hold current range
- ◆ 250VAC interrupt rating
- ◆ Fast time-to-trip
- ◆ Binned and shorted narrow resistance ranges available
- ◆ RoHS compliant, Lead-Free and Halogen-Free

Applications

- ◆ Customer Premises Equipment (CPE)
- ◆ Central Office (CO) / telecom centers
- ◆ Power ports
- ◆ LAN / WAN equipment
- ◆ Access equipment

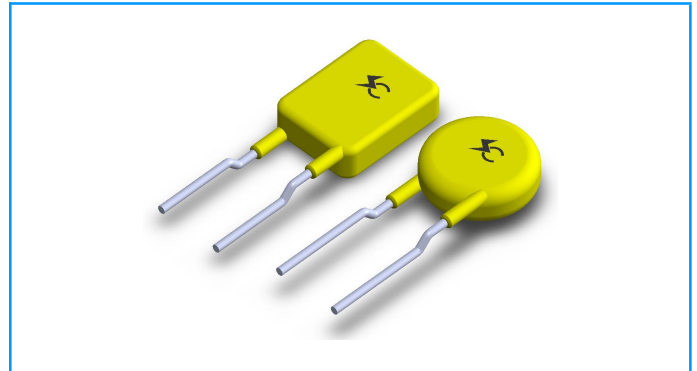

Electrical Parameters

Part Number	I_{hold} (A)	I_{trip} (A)	V_{maxi} (Vac)	I_{max} (A)	$P_{dtyp.}$ (W)	Maximum Time To Trip		Resistance	
						Current (A)	Time (Sec.)	R_{min} (Ω)	R_{max} (Ω)
SC250-080CW1A	0.08	0.16	250	3.0	0.8	0.35	4.0	20.0	35.0

I_{hold} = Hold current: maximum current device will pass without tripping in 25°C still air.

I_{trip} = Trip current: minimum current at which the device will trip in 25°C still air.

V_{maxi} = Maximum voltage that can be safely placed across a device in its tripped state under specified fault conditions.

I_{max} = Maximum fault current device can withstand without damage at rated voltage (V_{max})

$P_{dtyp.}$ = Power dissipated from device when in the tripped state at 25°C still air.

R_{min} = Minimum resistance of device in initial (un-soldered) state.

R_{max} = Maximum resistance of device in initial (un-soldered) state.

Caution: Operation beyond the specified rating may result in damage and possible arcing and flame.

Radial Lead Resettable Polymer PTCs

SC250-080CW1A

Temperature Derating Chart – I_{hold} (A)

Part Number	Ambient Operation Temperature								
	-40°C	-20°C	0°C	25°C	40°C	50°C	60°C	70°C	85°C
	Hold Current (A)								
SC250-080CW1A	0.124	0.110	0.095	0.080	0.066	0.059	0.051	0.044	0.033

Average Time Current Curves

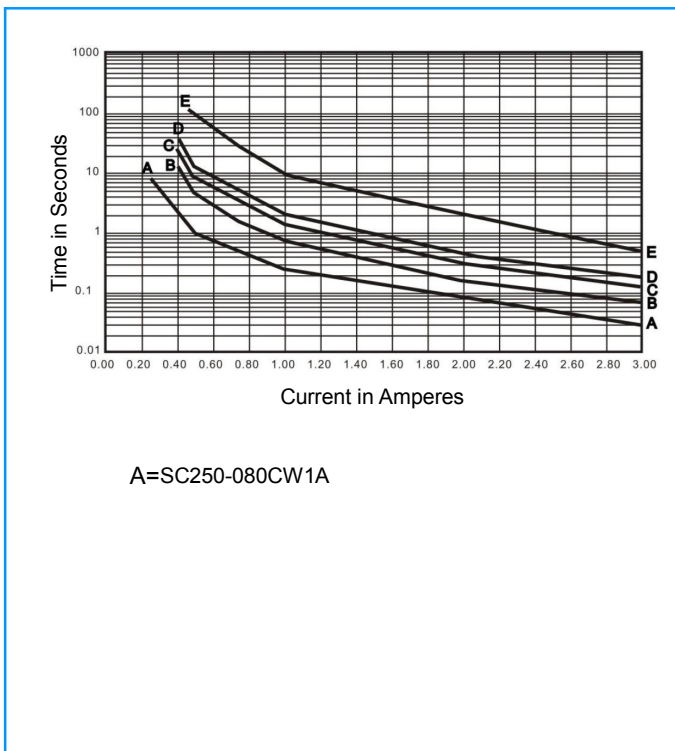

Temperature Derating Curve

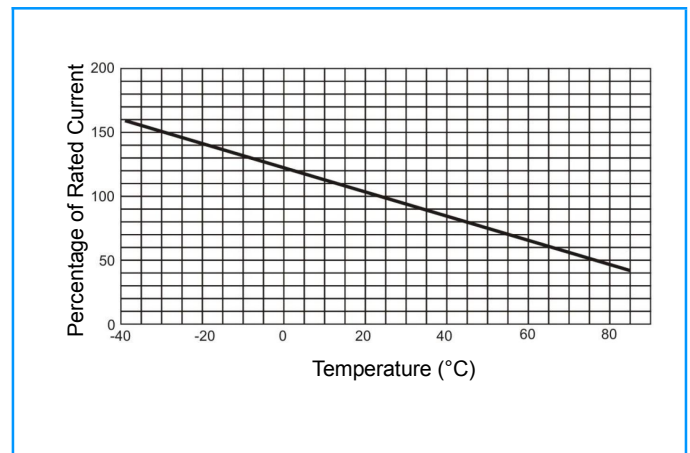

Test Procedures and Requirement

Test	Test Conditions	Accept/Reject Criteria
Resistance	In still air @25±2°C	$R_{min} \leq R \leq R_{max}$
Hold Current	60 min, at I_{hold} , In still air @25±2°C	No trip
Time to Trip	Specified current, V_{max} , @25±2°C	$T \leq$ Maximum Time To Trip
Frequency Current withstand	220V / I_{max} , 20 cycle	Resistance of the variation of the poor value: $\leq 30\%$
Failure mode	V_{max} , 60 minute	No burning
Withstand current and Voltage	V_{max} , I_{max} , 15minute	Resistance of the variation of the poor value: $\leq 30\%$

Radial Lead Resettable Polymer PTCs

SC250-080CW1A

Soldering Parameters

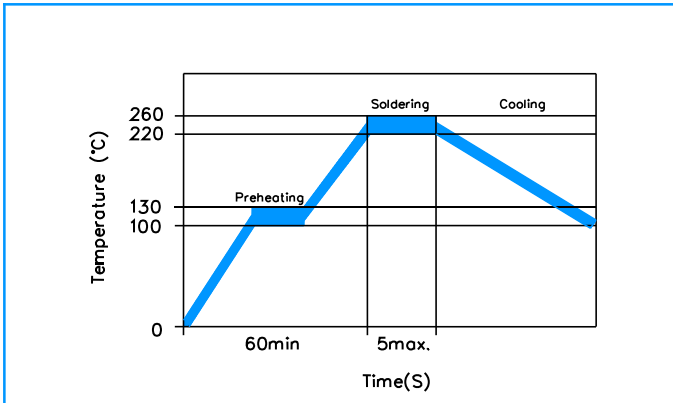

Pre-Heating Zone	Refer to the condition recommended by the manufacturer. Max. ramping rate should not exceed 4°C/Sec
Soldering Zone	Max. solder temperature should not exceed 260°C
Cooling Zone	Cooling by natural convection in air

Physical Specifications

Lead Material	Tin-plated Copper
Soldering Characteristics	Solder ability per MIL-STD-202, Method 208E
Insulating Material	Cured, flame retardant epoxy polymer meets UL 94V-0 requirements.
Device Labeling	Marked with 'SC', voltage, current rating

Part Numbering

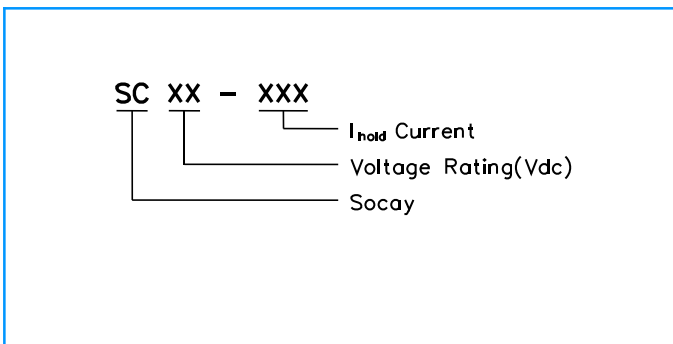

Part Marking

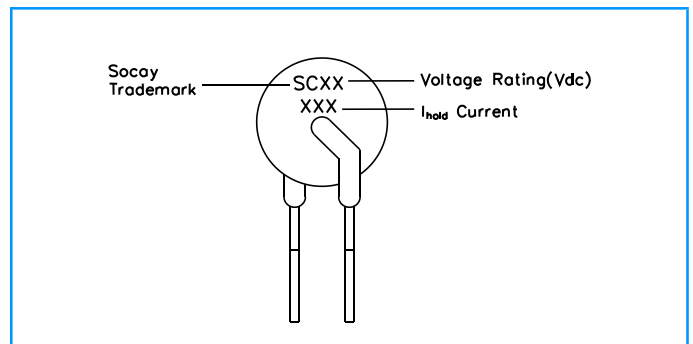

Radial Lead Resettable Polymer PTCs

SC250-080CW1A

Dimensions

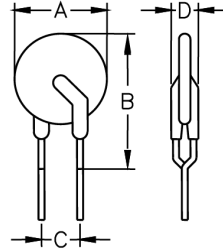

Figure1

Part Number	Figure	A		B		C		D		Lead (dia)		Packaging (Bulk Pack)
		Inches	mm	Inches	mm	Inches	mm	Inches	mm	Inches	Mm	
		Max.	Max.	Max.	Max.	Typ.	Typ.	Max.	Max.			
SC250-080CW1A	Figure1	0.236	6.0	0.394	10.0	0.200	5.1	0.181	4.6	0.024	0.6	1000